



AIRTRONICS®

M8

Instruction Manual





THANK YOU FOR ELECTING TO JOIN THE AIRTRONICS FAMILY. Always remember that we are as close as your nearest telephone, FAX machine, or mail box.

These instructions are intended to acquaint you with the many unique features of this modern, state-of-the-art equipment. Please read them carefully so that you may obtain maximum success and enjoyment from its operation.

We ask that you pay particular attention to the design of the transmitter. Notice that it has been human engineered for the most natural and precise control of your choice of operating cars or boats.

Be certain to read all the material in this manual, as well as that in the Fundamentals and Guidelines Manual.

SAFETY FIRST FOR YOURSELF, FOR OTHERS AND FOR YOUR EQUIPMENT

"SAFETY FIRST" is more than just a slogan when operating radio controlled models. Thus, we urge, especially with respect to radio controlled aircraft that:

FOR YOUR SAFETY:

AT THE TRACK OR LAKE...

DO NOT OPERATE YOUR TRANSMITTER unless your frequency is "clear". The transmitting signal frequency and/or channel number is shown on the transmitter and YOU MUST NOT turn on your transmitter while someone else is operating their model on that same frequency.

WARNING: IF YOU DELIBERATELY OR ACCIDENTALLY TURN ON YOUR TRANSMITTER WHILE ANOTHER MODEL IS IN OPERATION, THAT MODEL WILL GO OUT OF CONTROL. The same will happen to yours, so observe "clearing" the frequency: Only one person using a given frequency at a time. DO USE FREQUENCY FLAGS for the frequency your system uses and attach the appropriate flags to your transmitter antenna. DO OBSERVE all of the rules of the operating or flying site.

FREQUENCY IDENTIFICATION AND DISPLAY SYSTEM

The Federal Communications Commission (F.C.C.) specifies radio frequencies in MHz units. For convenience, the frequencies are designated by CHANNEL number or by colors. The frequencies for each band are listed in MHz and are designated as indicated. Numbered channel markers on the transmitter identify the specific channel. A yellow wind streamer identifies a 75 MHz transmitter.

75 MHz Non-Aircraft Band	
CHANNEL	FREQUENCY (MHz)
61	75.410
62	75.430
63	75.450
64	75.470
65	75.490
66	75.510
67	75.530
68	75.550
69	75.570
70	75.590
71	75.610
72	75.630
73	75.650

74	75.670
75	75.690
76	75.710
77	75.730
78	75.750
79	75.770
80	75.790
81	75.810
82	75.830
83	75.850
84	75.870
85	75.890
86	75.910
87	75.930
88	75.950
89	75.970
90	75.990

CHANNEL	27 MHz Surface	
	FREQ. (MHz)	SINGLE FLAG COLOR
1	26.995	Brown
1	27.045	Red
1	27.095	Orange
1	27.145	Yellow
1	27.195	Green
1	27.255	Blue

WARNING: The 75 MHz frequencies allocated for Model Radio Control use are exclusive; however, they are in close proximity to other types of radio usage in certain areas. Before operating your Model, check with the FCC Regional Office in your area to determine whether there is a potential danger or interference from other radio users. The FCC offices are usually listed in your telephone directory under the section designated to United States Government Offices. When dealing with the FCC, you should state the type of activity you are involved in (i.e., radio control of model boats or cars) and inquire if there are any commercial RF transmitters on or close to your frequency in Megahertz (MHz). Do not use R/C channel numbers since the FCC will not be able to correlate them with actual frequency. "Outside" radio interference may cause you to lose control of your model, possibly resulting in injury to yourself or others, or property.

SO REMEMBER:

- DO NOT OPERATE your transmitter at the track or lake, until you are certain your frequency is "clear".
- DISPLAY your frequency flag colors and channel identification on the antenna of your transmitter.
- REMEMBER that flags do not usually state the frequency on them and sometimes the colors are hard to distinguish. If you have an eyesight limitation or defect such as color blindness, double check the frequency flag designations with someone else.
- Turn your transmitter on only when you are sure no one else is using your frequency.
- WARNING:** Your model will go out of control and may cause some serious injury or damage if someone else turns on a transmitter on your frequency while you are operating your model.
- Respect all the rules of the operating site.
- At any time during the operation of your model, should you sense, feel or observe any erratic operation or abnormality, end your operation as quickly and safely as possible. DO NOT operate again until you are certain the problem has been corrected. TAKE NO CHANCES.

Table of Contents

Page

1. Introduction
2. Table of Contents
3. Features
4. Connectors
5. Battery Charging, Handle Position, Steering Wheel Tension Adjustment
6. Replacing Crystals
7. Transmitter Features and Controls
8. Transmitter Features and Controls
9. Display Panel
10. Display Panel Operation
11. Battery, Timer, Battery Alarm
12. Dual Rate
13. Steering End Point Adjustments
14. Throttle End Point Adjustments
15. Digital Trim
16. Steering Exponential
17. Throttle Exponential
18. Steering Servo Speed
19. Throttle Servo Speed
20. Model Name
21. Model Copy, Model Clear
22. Sub Trim
23. Trim Rate, Trim Reset
24. Response Switch
25. Lap Timer
26. Lap Timer cont.
27. Interval Timer
28. Servo Reverse, Starting Position
29. Command Signal, LCD Contrast, Key Lock
30. Direct Servo Controller
31. Position of Receiver Connectors

M8 System Features

- **Narrow Band FM Receiver and Transmitter:** For the best possible radio link between the transmitter and your model.
- **New Airtronics "Z" Servo Connectors:** Allows connecting to components of most other brands without plug changes.
- **Transmitter RF Frequency Modules:** Allows quick and positive channel and / or band changes, even between heats.
- **Three Channel Operation:** For additional scale functions.
- **Advanced Case Ergonomics:** For comfortable operation, well balanced with perfect wheel and grip alignment.
- **Adjustable Grip Length:** Adjustable for any hand width.
- **Interchangeable Grip Position:** For left or right handed users.
- **Steering Wheel Tension:** Adjustable to exact point desired.
- **Rechargeable Battery:** Drop-in NiCd battery available.
- **Transmitter Battery Monitor:** Displays battery voltage digitally in 0.1 volt increments from 8.0 to 13.1 volts
- **Transmitter Battery Alarm:** Provides audio beeps when battery drops to 9.1 volts, steady tone when it drops to 8.9 volts.
- **Large Display Panel:** High visibility, large characters.
- **Dual Rates:** Available on both steering and throttle channels.
- **Exponential:** Available on both steering and throttle channels.
- **End Point Adjustments:** Available on both steering and throttle channels.
- **Digital Trim:** One degree trim changes possible while running. Includes Sub Trim, Trim Rate, and Trim Reset functions.
- **Servo Speed:** Steering and throttle servo speed variable.
- **Ten Model Memory:** Stores all operational data for 10 different models. Includes Model Copy and Model Clear functions.
- **Response Switch:** Adjust servo response time while under way.
- **Digital Timer:** Multipurpose programmable timer can be set for total ON time, lap time, or as interval timer.
- **Servo Reverse:** Sets direction of steering and throttle servo.
- **Starting Position:** Exclusive feature for glow engine powered models, sets the throttle at high idle for easier starting.
- **Command Signal:** Selects one of ten different tones to be heard during any trim and function key operations.
- **LCD Contrast:** Sets the brightness of the screen at the best level for different ambient lighting conditions.
- **Key Lock:** Turns off programming keys to prevent accidental change or loss of stored data by inadvertent operation.
- **Direct Servo Controller:** Allows setting of model linkages and all transmitter data without actual transmission taking place.
- **Fully Compatible:** With all Airtronics accessories and most of those available from all major R/C equipment manufacturers.

Connectors

CAUTION!

- Your M8 system uses Airtronics **New "Z" Connectors**. The receiver is blue in color and should be used only with "Z" connector equipped servos, speed control, switch harness or batteries.
- The receiver and all "Z" configured components use a different pin polarity than previous servos, speed controllers, switch harnesses and batteries and should not be used together.

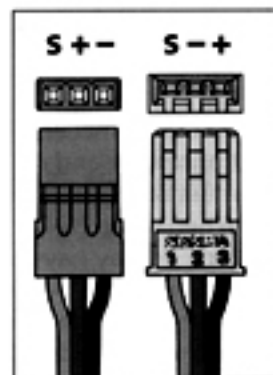

New "Z" Standard

To use your "Z" connector receiver with previous servos, etc. Conversion cable No. 99400Z must be used or new "Z" connectors installed by our service department.

To use previous receivers with "Z" connector servos, etc. Conversion cable No. 99399Z must be used.

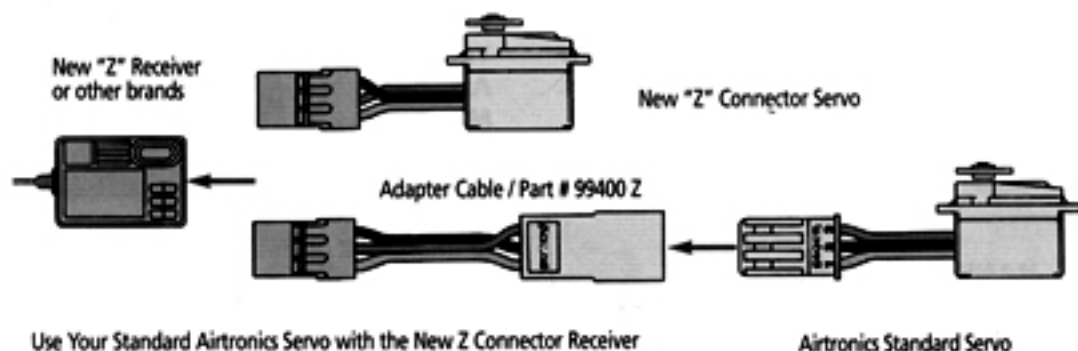
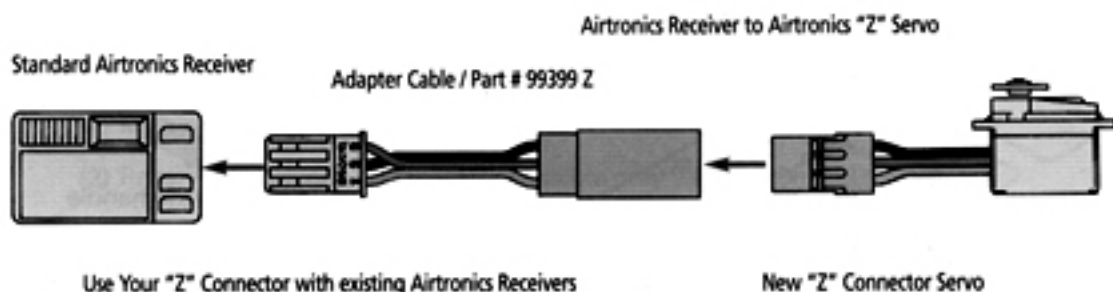

NI-CD BATTERY CHARGING

- Before connecting the charger, both transmitter and receiver power switches must be in the "OFF" position.
- When using Ni-Cd batteries for the first time or they have not been used for long periods, they may not accept a full charge. If so, they should be discharged and re-charged two or three times.

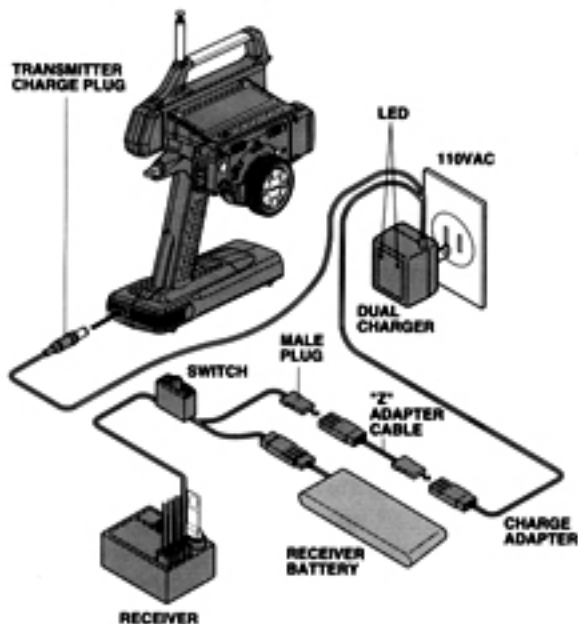

Ni-Cd Charging Time (Charger No. 95033)
 Transmitter 700 mAH Battery 12 Hours
 Receiver 425 mAH Battery 10 Hours
 Whenever a quick charger is used, the charge rate should not exceed one ampere.

HANDLE POSITION:

You will find the M8 to be especially well balanced, with the wheel and trigger aligned to maximize driving precision.

- Adjusting the handle position:
 - (1) Remove the RF module.
 - (2) Loosen the four screws indicated on the back side of the transmitter, pull down on the handle.
 - (3) With the handle positioned as desired, retighten the screws.

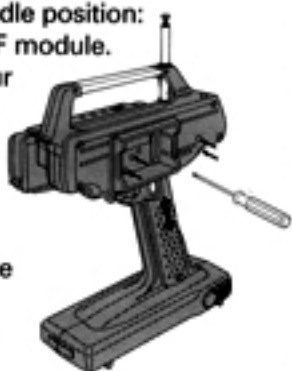

- Switching left to right hand handle position:

If you are left handed, the handle may be rotated as follows:

 - (1) Remove the RF module
 - (2) Remove the four screws indicated on the back side of the transmitter.
 - (3) Pull down and remove the handle from the top section. It only needs to clear the top, use care not to pull the connecting wires loose.
 - (4) Rotate the handle 180 degrees and replace it back in the top section.
 - (5) Install and tighten the four screws.

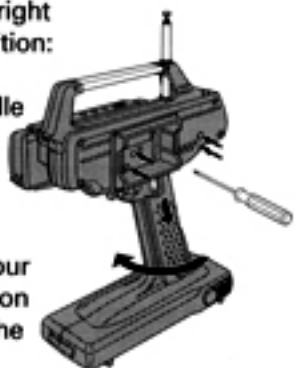

STEERING WHEEL TENSION ADJUSTMENT:

The steering wheel tension is factory set to the softest position. It can be adjusted using a 1.5mm hex wrench as indicated; turn the screw in to increase tension.

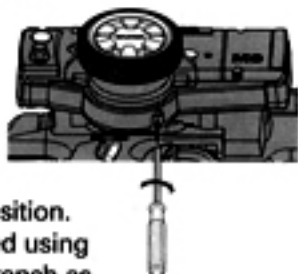

REPLACING CRYSTALS

Transmitter:

(Note that Federal Regulations prohibit changing crystals in the 75 MHz band).

- (1) Remove the crystal cap, remove the installed crystal and replace it with the new one.
- (2) To change from the 27MHz to the 75 MHz band, or vice versa, it is necessary to change the transmitter RF module.
- (3) When changing the module, assure that it is firmly installed, improper or loose installation will cause malfunctions.
- (4) Be sure to use the crystal cover to protect the crystal.
- (5) Your M8 transmitter uses Airtronics RF Module No. 93927 for 27 MHz and No. 92975 for 75 MHz; they are not interchangeable with other modules.

Receiver:

- (1) Remove the installed crystal and replace it with the new one.
- (2) Receiver frequency changes are possible only within the respective band.
To change bands you must replace the receiver.
Use Airtronics receiver No. 92837 for 27 MHz, No. 92836 for 75 MHz.
- (3) Be sure to install the silicone ring to protect the crystal from vibration and damage.

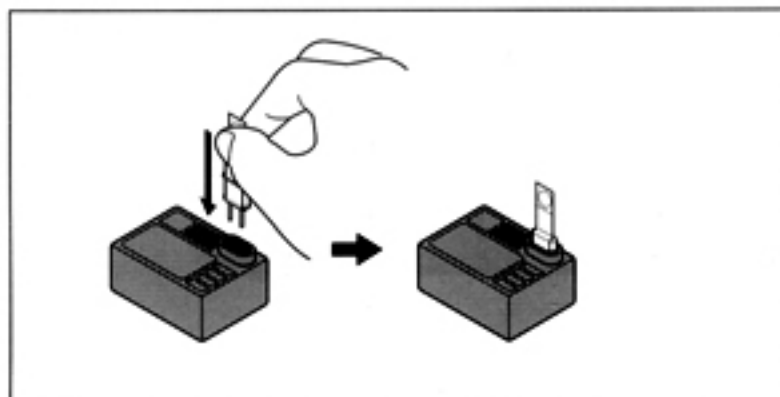

Transmitter Features And Controls

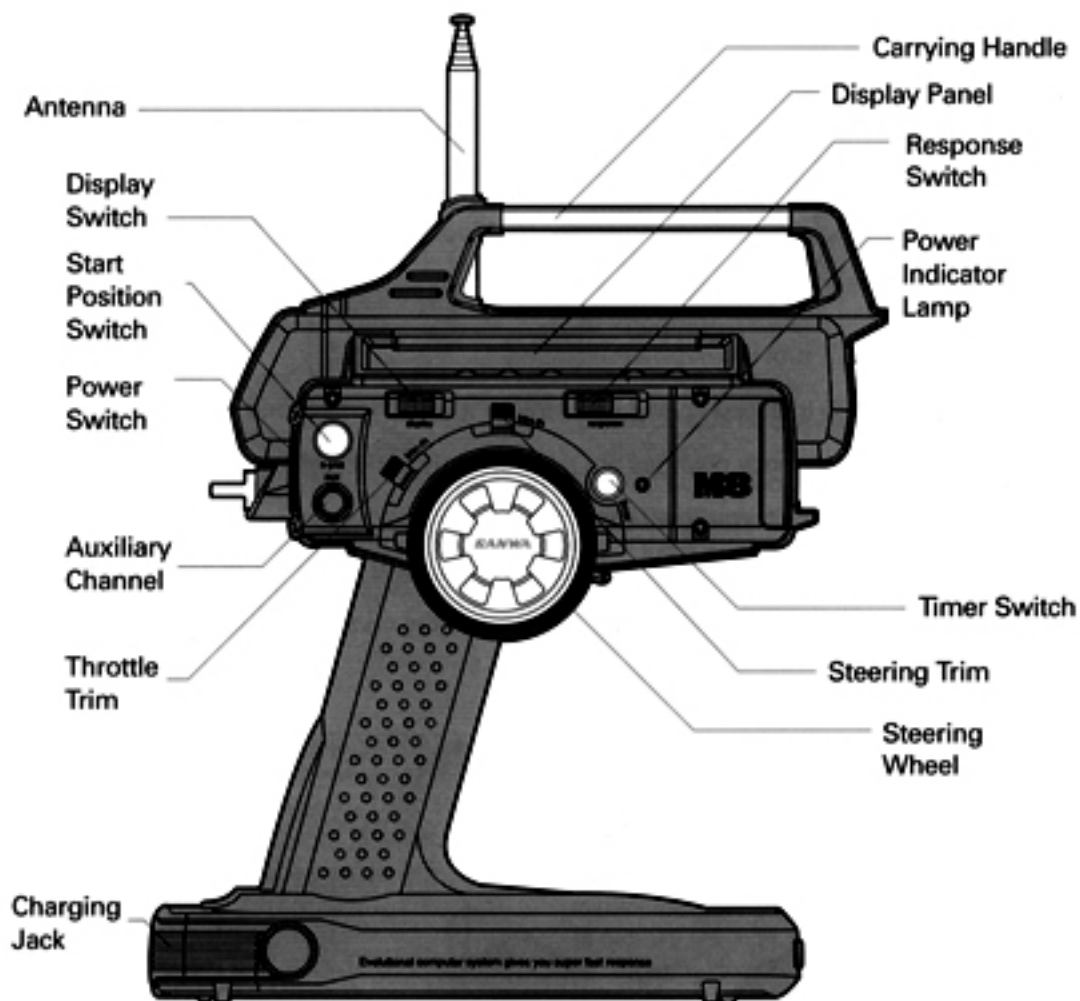

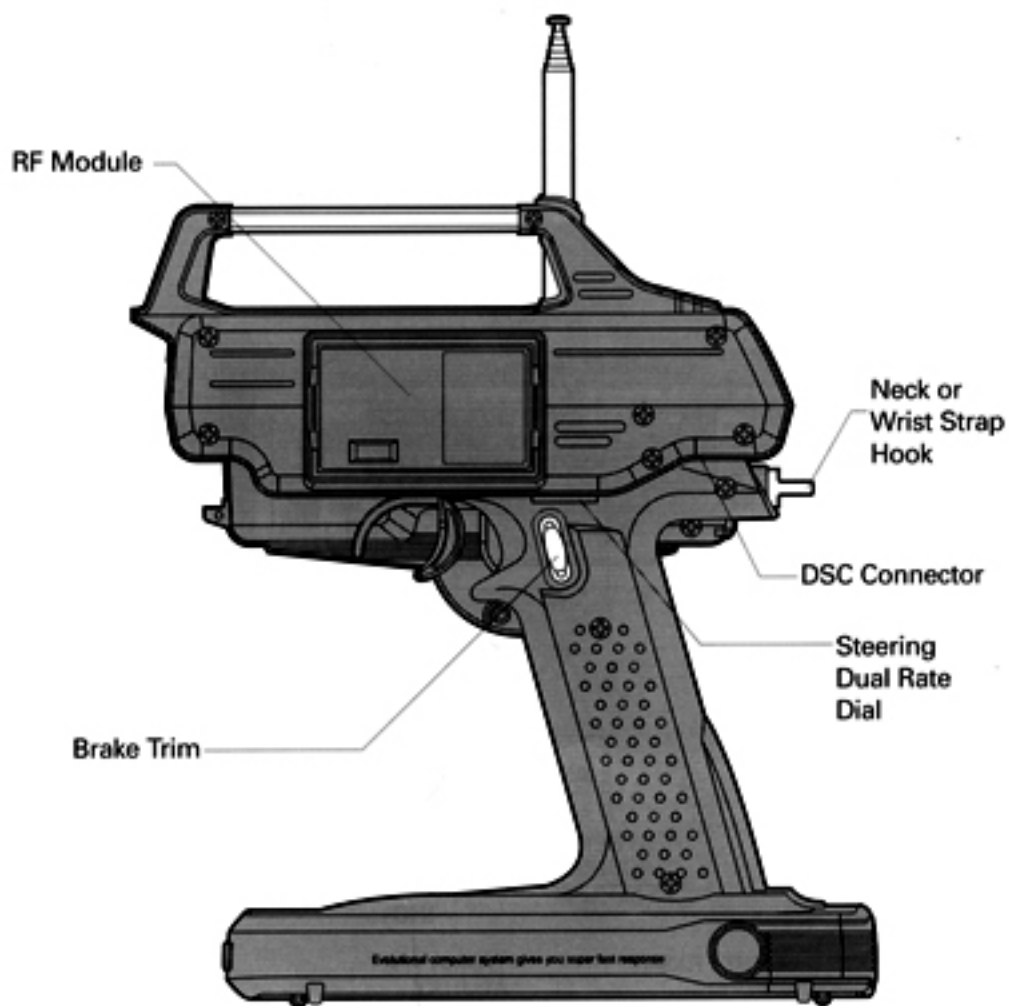

DISPLAY PANEL

Your M8 transmitter's large multiple display shows its many possible functions at a glance. It enables the various functions to be set into its extensive memory, stored, and copied, and provides instant confirmation of all data entered.

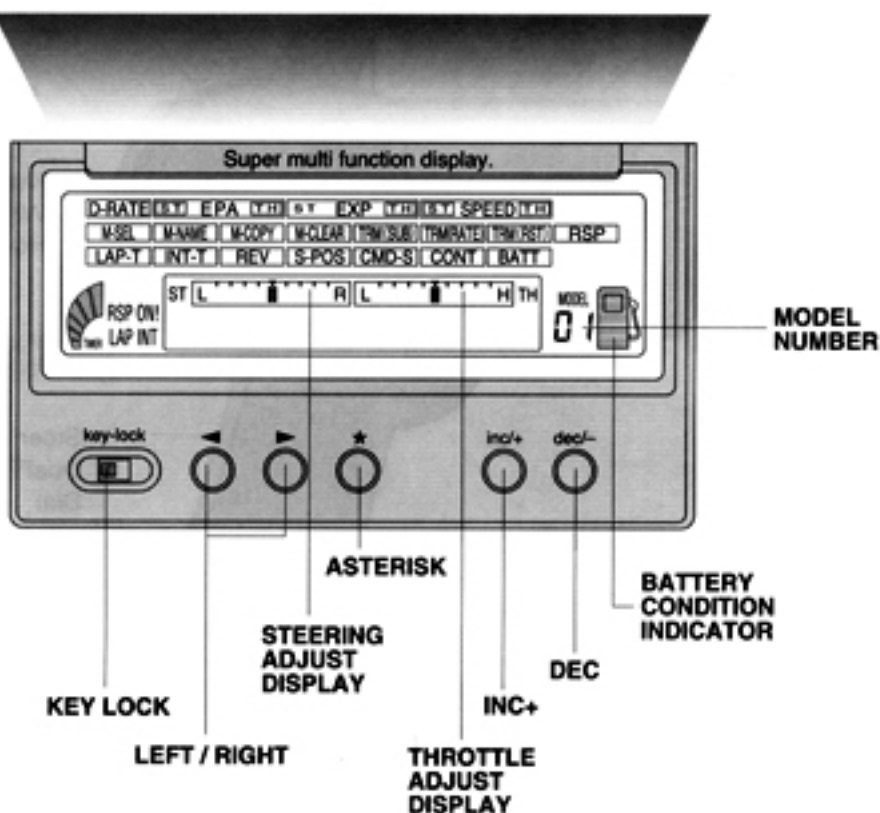
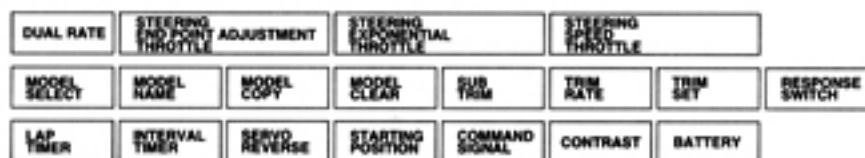

BASIC OPERATION OF THE DISPLAY PANEL

(1) Using the Function Select Keys < >, move the cursor left or right, up or down, to the desired function name. Pressing the < > Keys at the same time moves the cursor up and down.

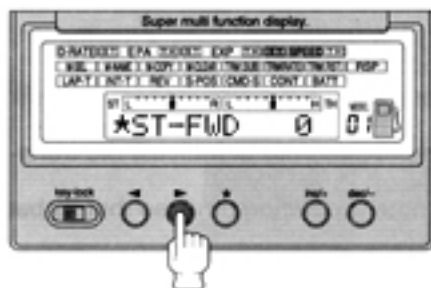

(2) When the display shows an asterisk (*), you can scroll the menu for further functions.

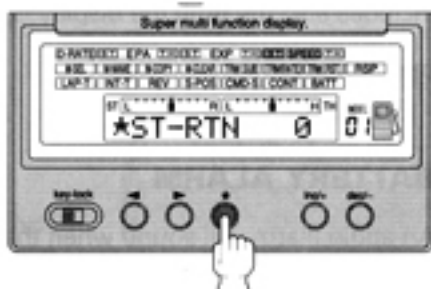

(3) The indicated value can be adjusted with the Inc.+ or Dec.- Keys. Depress both the Inc.+ and Dec.- Keys to reset to the original value.

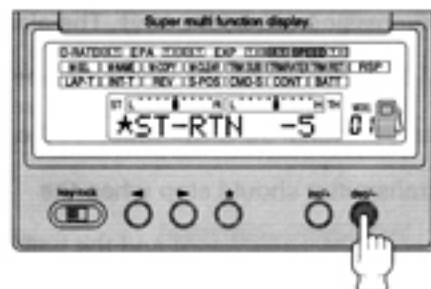

BATT (BATTERY)

The Battery Voltage is indicated in 0.1V steps from 8.0V to 13.1V.

TIMER OPERATION

Under BATT, depressing the Inc.+ and Dec.- Keys simultaneously will reset the timer to indicate the transmitter operating time so that its battery life can be estimated.

Note: The transmitter operating time includes also the time the display is operational.

BATTERY ALARM

An audio alarm will sound when the transmitter's battery voltage drops to 9.1V. The alarm can be stopped by depressing any of the keys. The alarm will re-start when the voltage drops an additional 0.2V. Operation of the transmitter should stop when the second alarm is heard and the battery must be replaced or recharged.

Continued operation will result in an out of control model.

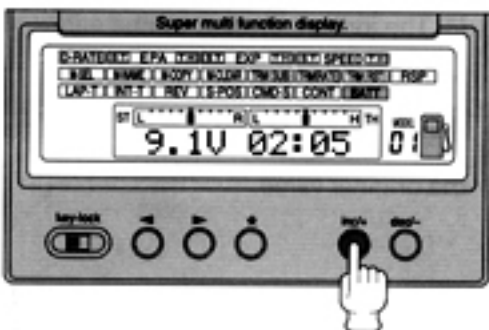
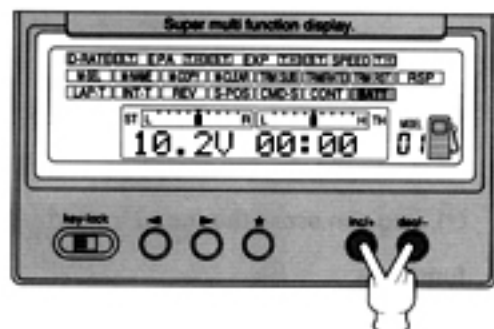
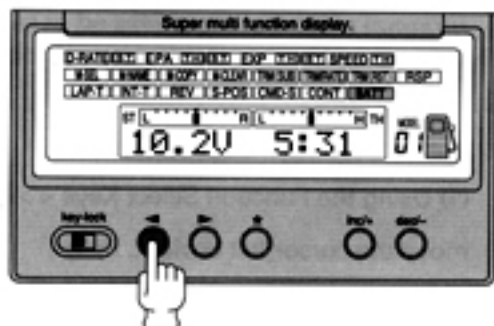

D-RATE (STEERING DUAL RATE)

This function is recommended to correct an under- or over-steering condition. It can be adjusted with the Steering Dual Rate Dial on top of the handle while driving your model.

- (1) First adjust the steering to neutral
- (2) Set the Steering Dual Rate Dial to its center.



Dual Rate Dial



- (3) Depress the Function Select Key and move the cursor to D- RATE.

- (4) Turn the Steering Wheel clockwise or counter-clockwise and depress the Inc.+ or Dec.- Key until the steering linkage hits its stops, then decrease the indicated reading by 25%. **Caution:** Do not hold the steering in its stopped condition for long as the servo will draw excessive current and possibly be damaged.

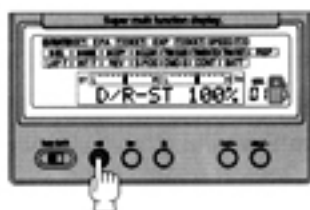

- (5) Adjust the Steering Dual Rate with the Steering Dual Rate Dial. Turning the dial to the right will increase the steering angle; turning the dial to the left will decrease it. **Caution:** If Steering Dual Rate is not desired, the dial should be kept at its full right position. Setting the Steering Dual Rate at 150% and the Steering EPA at 150% may increase the dead band (lack of sensitivity at center) of the steering servo.

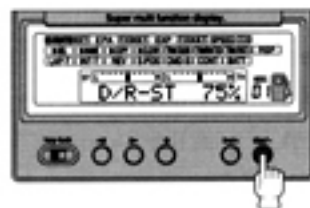

ST-EPA (STEERING END POINT ADJUSTMENT)

This function is used to correct a model's turning radius if it differs from left to right.

(1) First adjust the Steering Trim, then the EPA.

(2) Depress the Function Select Key and move the cursor to ST-EPA.

(3) Turn the Steering Wheel clockwise and set the right steering angle with the Inc.+ or Dec.- Key as desired. Then turn the Steering Wheel counter-clockwise and set the left steering angle with the Inc.+ or Dec.- Key.

Note: The recommended standard setting is 100%.

Caution: When setting the Steering EPA, adjust the Steering Trim first.

Set the Steering Trim as follows:

- (1) Reset the trim
- (2) Set the servo neutral.
- (3) Adjust the servo center with the Sub-Trim.

Remember that setting the Dual Rate at 150% and the Steering EPA also at 150% may result in increased servo dead band.

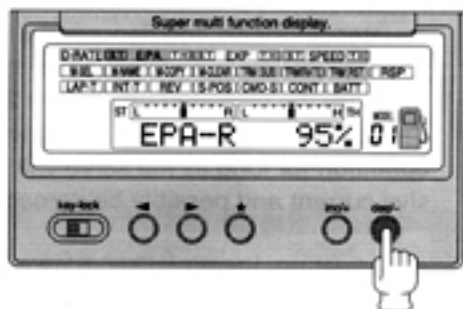
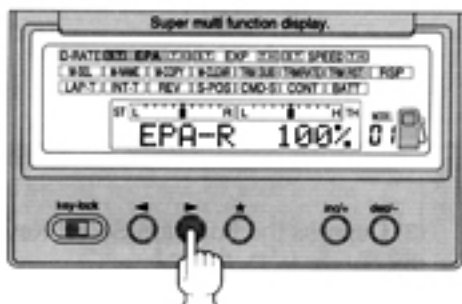
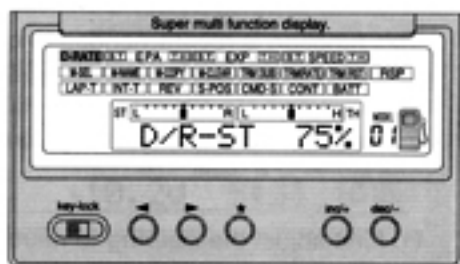

EPA TH (THROTTLE END POINT ADJUSTMENT)

Throttle EPA will adjust the carburetor throttle arm stroke, the high point of an Electronic Speed Controller (ESC) and the braking.

(1) Depress the Function Select Key and move the cursor to TH-EPA.

(2) For engine powered cars, to set the high throttle position, pull the Throttle Trigger to its high position and adjust the position of the servo and engine throttle arm with the Inc.+ or Dec.- key.

Note: For electric motor powered cars using an ESC, set the EPA high position to 100% unless a low speed power response is desired in which case a setting of 50 to 70% should be used.

(3) To adjust braking on engine powered cars, push the Throttle Trigger all the way forward and adjust the brake with the Inc.+ or Dec.-Key. To adjust the brake function of the electric motor powered car with an ESC, set the brake to 100% while pushing the throttle trigger to its forward position.

Note: It is possible to set the brake value to 160% maximum. While driving the car, braking action can be adjusted by using the Brake Trim Wheel located on the upper handle.

The Brake Trim on the other side of the handle is provided for the left-hand user. Please use the Trim Lock to avoid undesired operation.

Caution: On an engine powered car or boat, if the throw of the throttle servo is set excessively high, it may cause the servo to stall, draw high current and possibly result in damage to it.

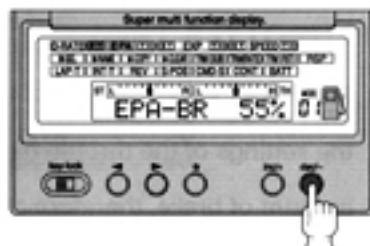
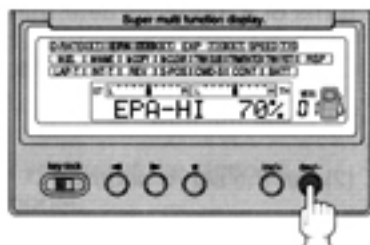
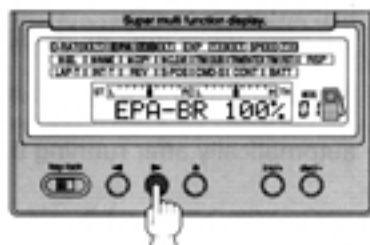

Brake
Trim Lock

OPERATION OF THE DIGITAL TRIM

Your Airtronics M8 transmitter utilizes a Digital Trim system which eases adjusting the trims while operating your model. Changes as fine as one degree can be made. In addition, it has an Auto-Trim System which memorizes the trim position automatically after running the model.

STEERING TRIM

The Steering Trim is used to correct any inherent differences in the right and left turns of a model as determined by its mechanical characteristics.

Caution: When adjusting the Steering EPA, first adjust the Steering Trim as follows.

- (1) Reset the trim.
- (2) Set the servo neutral
- (3) Adjust the servo center with the Sub-Trim.

STEERING TRIM

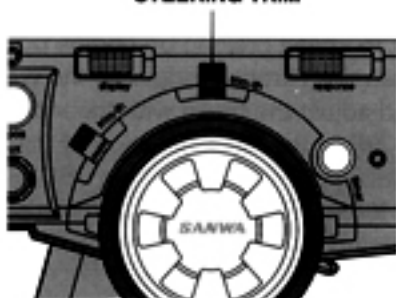

THROTTLE TRIM

The M8's Center Trim is not affected by the settings of the throttle high or the amount of brake, therefore changing the neutral adjustment will not affect the brake setting.

THROTTLE TRIM



EXP (EXPONENTIAL)

This M8 function modifies the servo (or ESC) action in relation to the movement of the steering wheel or the throttle trigger. Adjusting it in the Positive (+) direction will quicken the action from neutral; adjusting it in the Negative (-) direction will lessen it.

Steering Exponential

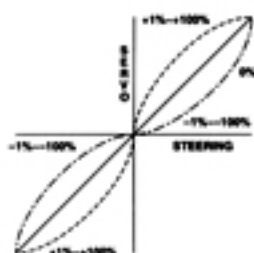

Throttle Exponential

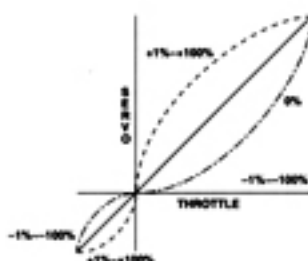

Solid Lines Indicate Linear Operation

ST EXP (STEERING EXPONENTIAL)

Three settings, QUICK, LINEAR and MILD will allow you to set the steering response to that most effective for your particular model.

Generally, if your model over-steers, adjust the ST EXP towards the Negative (-) direction. If it under-steers, adjust it towards the Positive (+) DIRECTION.

- (1) Depress the Function Select Key to move the cursor to ST-EXP.

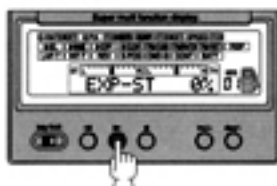

- (2) If the steering response is too fast, depress the DEC.- Key to lessen it.

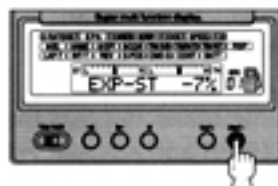

- (3) If the steering response is too mild, depress the INC. + Key to increase it.

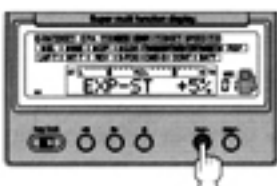

- (4) If you opt not to use the Steering Exponential or can not decide on the proper setting, set it to 0% (Linear).



EXP TH (THROTTLE EXPONENTIAL)

Three settings, QUICK, LINEAR and MILD will allow you to set the throttle response to that most effective for your model. Generally, if an R/C car track is slippery or the model is over responsive to throttle, set the EXP-TH towards the Negative (-) direction. If the track provides high traction or if more torque is desired, set it towards the Positive + direction. The throttle high and brake can be adjusted independently.

(1) Depress the Function Select Key, move the cursor to TH-EXP.

(2) If the power is applied too rapidly, depress the DEC- key and adjust it towards the Negative (-) direction.

(3) If the power response is too mild, depress the INC+ key and adjust it towards the Positive (+) direction.

(4) To re-adjust the brake, depress the Scroll Key to EXP-BR and adjust it with the INC.+ or DEC.- Keys.

(5) If you opt not to use Throttle Exponential or can not decide on the proper setting, set it to 0% (Linear).

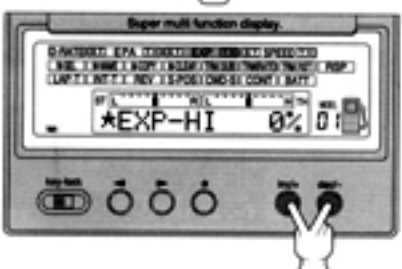
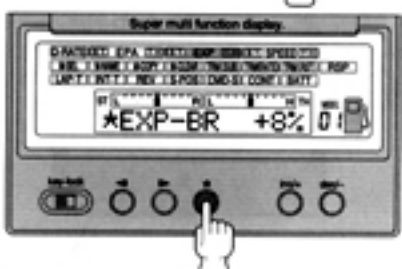
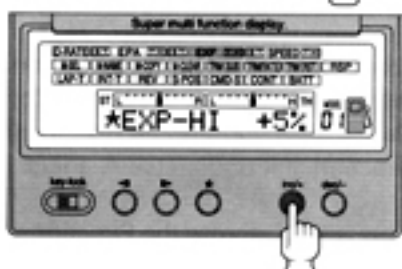
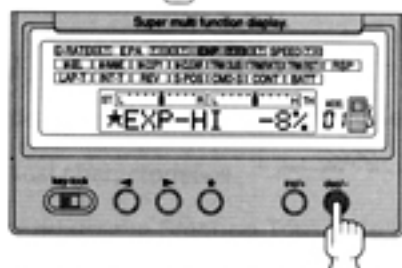
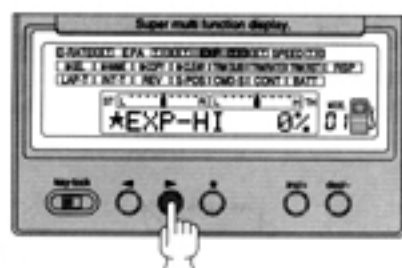

SPEED (SERVO SPEED)

This function sets the speed at which the servos (or ESC) will respond. This assures you of smoothly controlled turns and precise throttle control.

ST SPEED (STEERING SERVO SPEED)

This function sets the speed of the servo relative to the steering wheel rotation. It can be set independently for initial servo operation and its return to neutral. However, if the steering servo speed is set lower than the actual speed of the servo, its speed is not affected.

(1) Depress the Function Select Key and move the cursor to ST-SPEED.

(2) To decrease the initial servo speed, depress the scroll key to display ST-FWD and adjust the value with the DEC.- Key.

(3) To increase the servo return speed, depress the Scroll Key to display ST-RTN and adjust the value with the DEC- Key.

(4) if you opt not to use the Steering Servo Speed function, or can not decide on the proper setting, set it at 0% (linear).

Note: For R/C car driving, it is important to adjust the servo response for the most effective steering without over steering. The Steering Speed Function, when properly set, will reduce unnecessary steering with smooth cornering.

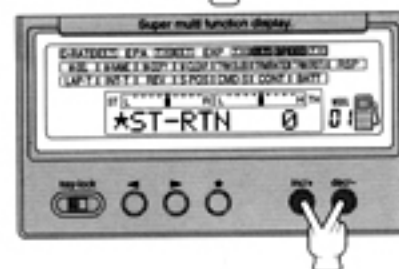
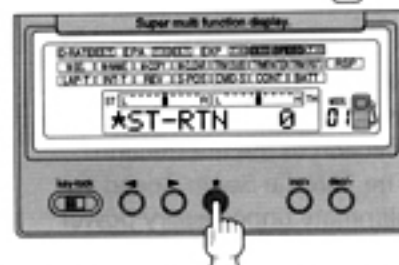
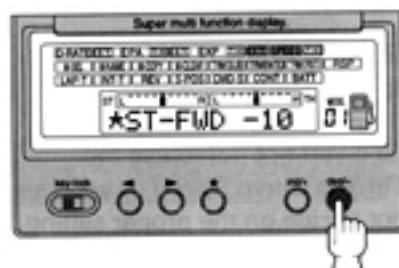

SPEED TH (THROTTLE SERVO SPEED)

This function sets the throttle servo (or ESC) reaction relative the movement of the throttle trigger. It does not have any effect as the trigger returns to neutral or when the brake is used.

(1) Depress the Function Select Key and move the cursor to TH-SPEED.

(2) To delay the throttle servo speed, depress the DEC.- Key.

(3) If you opt not to use the Throttle Servo Speed or you can not decide on the proper setting, set it at 0% (Linear).

Note: For R/C car driving, it is important to match the throttle reaction to the tire traction. The Throttle Servo Speed will eliminate unnecessary power and provide the proper tire grip for smooth driving.

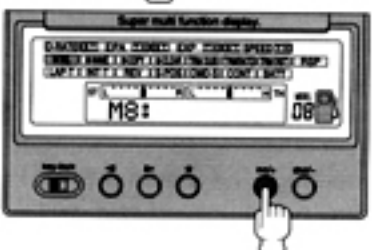
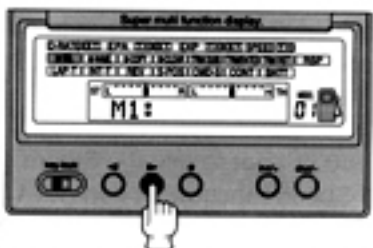
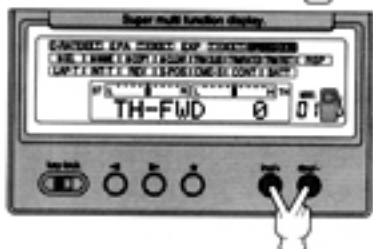
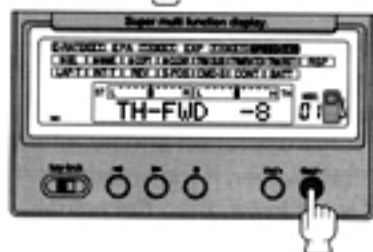
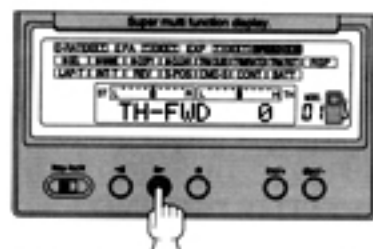

M-NAME (MODEL NAME)

Each Model Name can include up to eight characters.

(1) Depress the function Select Key and move the cursor to M-NAME.

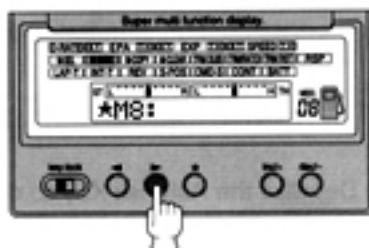

(2) Depress the INC.+ or DEC.- Key to select the characters.

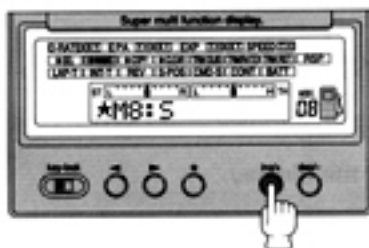

(3) Depress the asterisk (*) Key to advance to the next character.

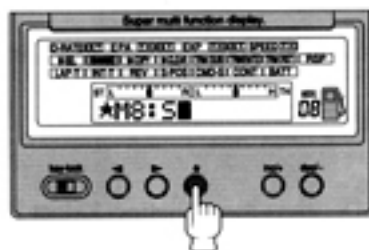

(4) Repeat steps (2) and (3) to complete the model name. Depress the INC.+ and DEC.- Keys simultaneously to display the first character of each group.

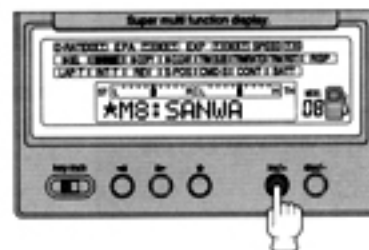

M-COPY (MODEL COPY)

It is possible to transfer all data from one model to another.

(1) Depress the Function Select Key and move the cursor to M-COPY.

(2) Depress the Asterisk Key to display the model you wish to copy to.

(3) Depress the INC.+ and DEC.- Keys simultaneously; EXECUTING will appear on the display.

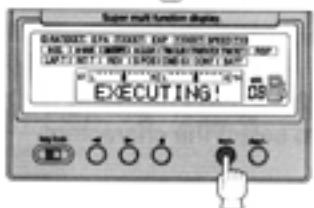
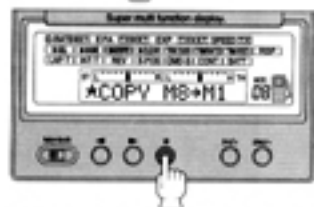
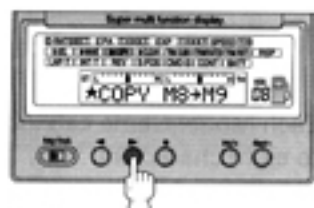

M-CLEAR (MODEL CLEAR)

You can clear any model memory that you no longer need.

(1) Depress the Function Select Key and move the cursor to M-CLEAR.

(2) Depress the Asterisk Key to scroll to the model you wish to clear.

(3) Depress the INC.+ and DEC.- Keys simultaneously; EXECUTING will appear on the display.

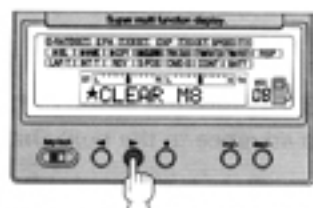

TRIM (SUB)

This function will readjust the steering and throttle trim so that the trim levers can remain at their center. When adjusting the linkages, the Trim Center should be set first with the Sub-Trim.

(1) Before adjusting the linkage, set the position of the Trim Lever for the Steering or Throttle Sub-Trim to its center (0%).

(2) Install the servo arm as close as possible to its neutral position.

(3) Depress the Function Select Key and move the cursor to TRM(SUB).

(4) Depress the Asterisk Key to display either SUB-ST or SUB-TH.

(5) Depress either the INC.+ or the DEC.- Key to set the neutral position.

Note: Preset the servo arm to neutral as closely as possible. If the Sub-Trim and the Main Trim are adjusted to their maximum position, some dead band may appear at the Steering Wheel and Throttle Trigger.

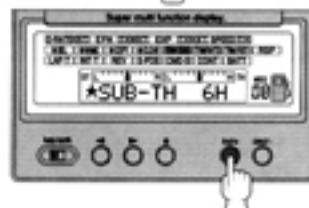
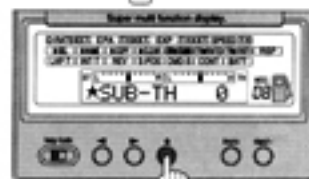
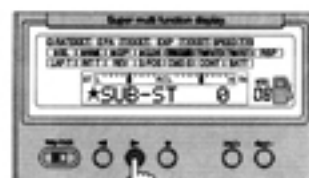
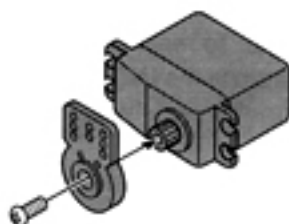

TRM(RATE) (TRIM RATE)

This function will adjust the degree of trim available.

(1) Depress the Function Select Key and move the cursor to TRM(RATE).

(2) Depress the DEC.- Key to adjust the Trim Rate.

Note: To reset the Trim Rate to 100%, depress the INC.+ and DEC.- Keys simultaneously.

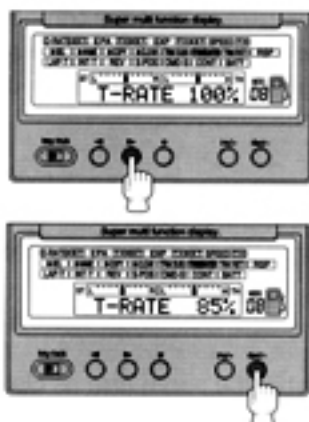

TRM(RST) (TRIM RESET)

This functions will set the positions of the Main Trim and Sub Trim into the Trim Memory.

(1) Depress the Function Select Key and move the cursor to TRM(SUB).

(2) Depress the Asterisk Key and select either Steering or Throttle.

(3) Depress the INC.+ or DEC.- Keys to set the data.

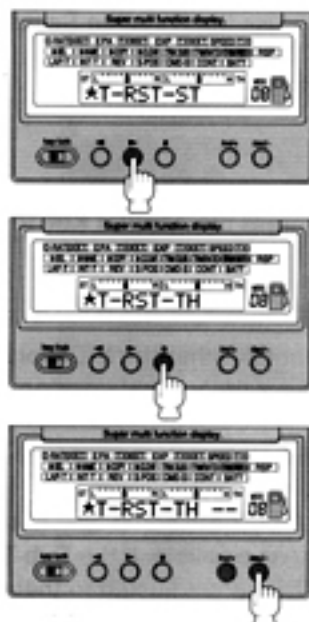

RSP (RESPONSE SWITCH)

This functions adjusts the Steering or Throttle Response Time. This original and unique feature will result in sharp steering and precise throttle response for optimum model performance.

(1) Depress the Function Select Key and move the cursor to RSP.

(2) Depress the Asterisk Key and select either RSP-ST or RSP-TH.

Response
Switch



(3) Turn the Response Switch to ON. RSP ON will appear on the display.

(4) To quicken the response, depress the INC.+ Key; it is adjustable from 0 (Linear) to +10 (Very Quick).

(5) For milder response, depress the DEC.- Key; it is adjustable from 0 (Linear) to -10 (Very Mild).

Note: If an adjustment of the Response Time if not desired, set it to 0 by depressing the INC.+ and DEC.- Keys simultaneously.



LAP TIMER

This function will measure, and record each Lap Time up to 99 laps.

(1) Depress the Function Select Key and move the cursor to LAP-T.

(2) Depress the INC.+ or DEC.- Key to turn the Lap Timer ON.

(3) Depressing the Asterisk Key will display the Target Time.

(4) Depress either the INC.= or DEC.- Keys to set the Target Time. It can be set from 10 to 60 seconds.

(5) To start the time, depress the Timer button located on the right side of the Steering Wheel. The Display will indicate the Lap Timer as being ON or OFF.

(6) Depressing the Timer button again; the Lap Time will be displayed for 3 seconds, then the timer will re-start. The Timer Button is inoperable during the 3 seconds.

(7) An audio alarm will beep 5 seconds before the Target Time is reached. When the Target Time has elapsed, a steady tone will sound.

Note: Depressing the Timer button after the Target Time has elapsed will display the Total Time.

If it is desired to stop the Lap Timer before the Target Time is reached, depress the Time button for 3 seconds, or depress the INC.+ and DEC.- Keys simultaneously.

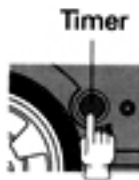
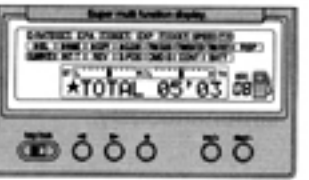
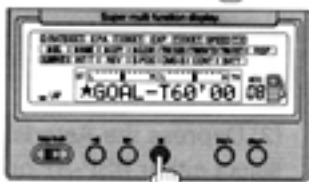
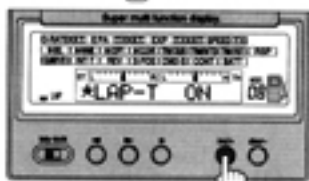
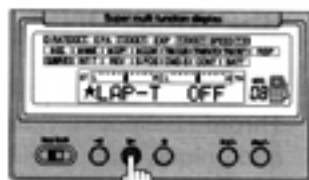

(8) To display the Lap Time after a run, depress the Asterisk Key. Depressing the INC.+ Key will display the first Lap Time relative to the average Lap Time.

(9) To delete the Lap Time from the memory, depress the Scroll Key to show the Total Time and depress the INC.+ and DEC.- Keys simultaneously; LAP-CLR will appear on the display. Depress the INC.+ and DEC.- Keys simultaneously again to delete the Lap Time.

Note: Depressing the DEC.- Key alone when LAP-CLR is displayed will return the display to the Total Time.

* The Target Time is not deleted. Whenever the Lap Timer is used, it automatically erases all previous lap data.

(10) Upon stopping the Lap Timer, its setting is automatically turned OFF; to use it again, first re-set it to ON.

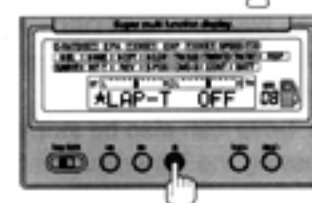
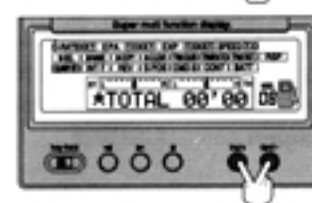
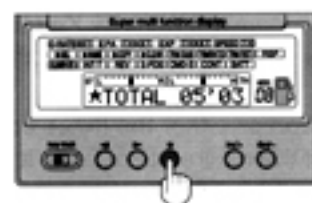
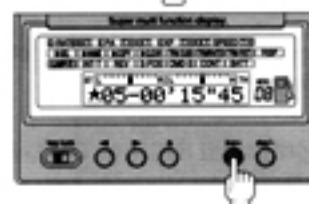
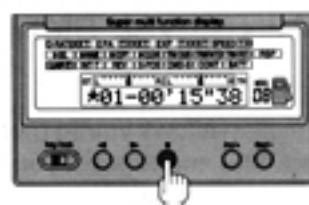

INT-T (INTERVAL TIME)

This function allows you to measure the Elapsed Time and to see if you are running within your intended Target Time.

(1) Depress the Function Select Key and move the cursor to INT-T.

(2) Depress the INC.+ or DEC.- Keys to display INT-T ON.

(3) Depress the Asterisk Key to display the pre-set time; it can be from 3*00 to 59*90.

(4) Depress either the INC.+ or the DEC.- Key to set the desired Lap Time. It can be set to within 0.1 second.

(5) The Timer is started by depressing the Timer Button located at the right side of the Steering Wheel; the display will indicate ON or OFF. The alarm will beep when the Target Time entered has elapsed.



* Depressing the Timer Button after the Timer has started will reset the Timer to start again.

(6) If it is desired to stop the Elapsed Timer, depress the INC.+ and DEC.- Keys simultaneously. This is effective when the cursor is on INT-T.

* The Timer can also be stopped by depressing the Timer Button for 3 seconds.

(7) When the Elapsed Timer is stopped, it is automatically turned OFF.

If it is to be used again, it must first be turned ON.



5*3



REV (SERVO REVERSE)

This functions reverses the direction of the servo movement.

- (1) Depress the Function Select Key and move the cursor to REV.
- (2) Depress the Asterisk Key, select either ST (Steering), TH (Throttle) or AUX (Auxiliary).
- (3) Depress either the INC.+ or the DEC.- Keys to change the direction of the servo.

S-POS (STARTING POSITION)

This functions is exclusively for use in a glow-engine powered R/C car or boat. It does not apply to any electric powered models. It eases starting the engine by setting its idle higher when it is being started.

- (1) Depress the Function Select Key and move the cursor to S-POS.
- (2) Set the Throttle Trim at its neutral center, then depress the Starting Position Switch.
- (3) Depress the INC.+ and set it slightly higher than the normal idling position. If increased by more than 1%, the alarm will sound.

Note: Since it is not used with electric powered models, set the S-POS at 0% when using your M8 with one. The alarm will not sound under this condition even though the S-POS switch is ON.

* Be sure the Throttle Trim neutral is initially set at its center. If not so, the servo may not move to the intended starting point.

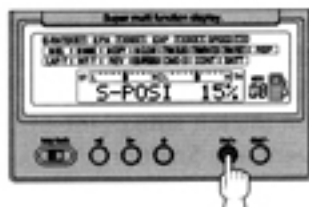
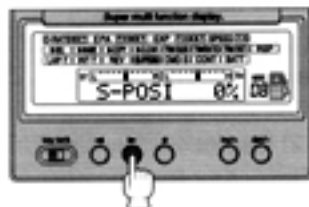
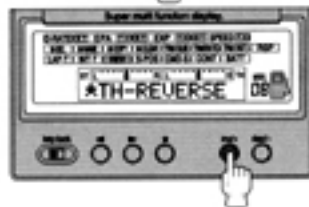
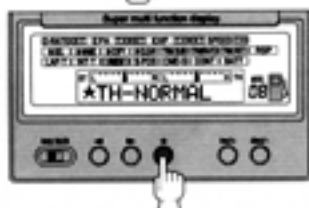
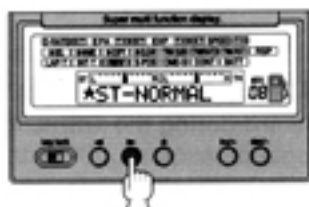

CMD-S (COMMAND SIGNAL)

This function will change the audio tone heard during the Trim and Function Key operation.
One of ten different tones can be selected.

(1) Depress the Function Select Key and move the cursor to CMD-S.

(2) Depress the INC.+ or DEC.- Key to select the desired tone. Select OFF to silence it completely.

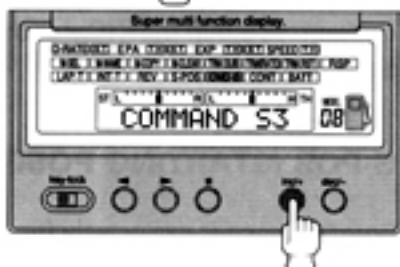

CONT (LCD CONTRAST)

This function adjusts the brightness of the LCD (Liquid Crystal Display) screen.

(1) Depress the Function Select Key and move the cursor to CONT.

(2) Depress either the INC.+ or the DEC.- Key to adjust the LCD brightness.

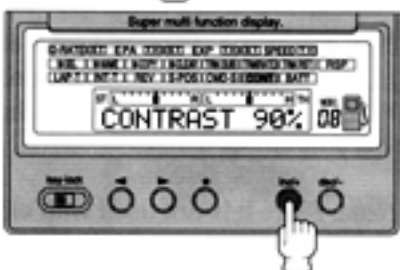
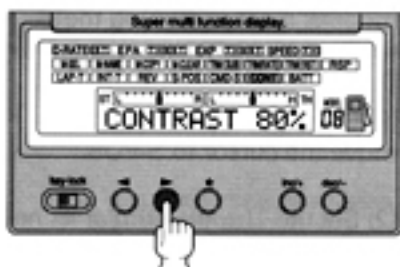

KEY LOCK

This function protects you from losing any data stored in the M8's memory through accidental manipulation of the keys.

Turning on the Key Lock Switch located on the left side of the LCD screen will prevent any function changes by depressing any of the keys.

Key Lock



DSC (DIRECT SERVO CONTROLLER)

The M8's Direct Servo Controller serves to allow adjustment of the linkages on your model and all settings on the transmitter without emitting a signal and causing interference to others on the same frequency channel.

To use the DSC on glow engine powered models, use the DSC equipped Switch Harness No. 97031Z.

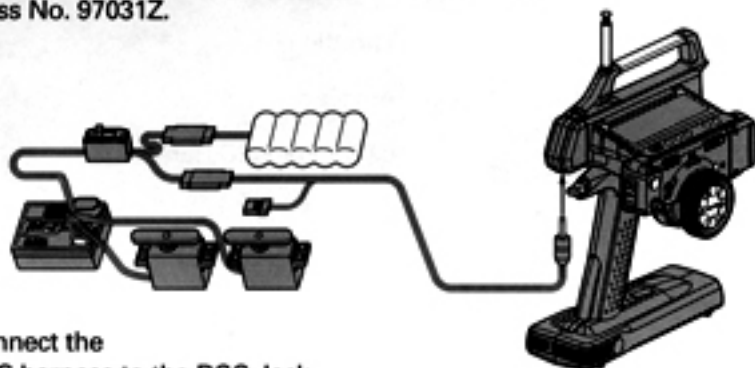

- (1) Connect the DSC harness to the DSC Jack on the side of the transmitter.
A DSC indication will appear on the display.
- (2) Connect the other end of the DSC harness to the charging connector on the Switch Harness.
- (3) To use the DSC Function, turn ON the receiver Switch Harness.

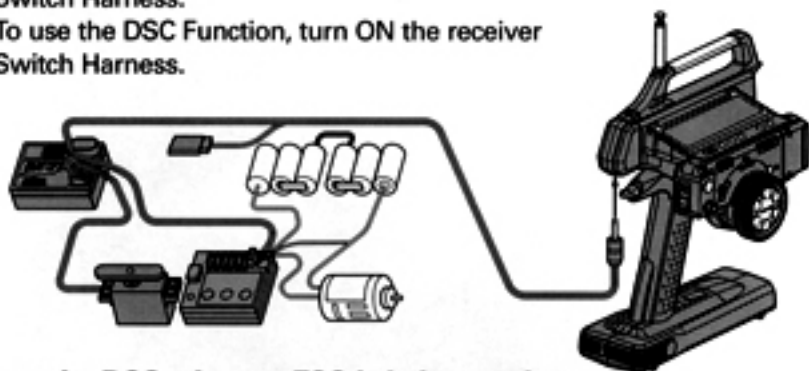

To use the DSC when an ESC is being used.

- (1) Connect the DSC harness to the DSC jack on the side of the transmitter.
A DSC indication will appear on the display.
- (2) Connect the other end of the DSC harness to the battery connector on the receiver.
- (3) To use the DSC Function, turn ON the ESC power switch.

Note:

It is not necessary to turn ON the transmitter when using the DSC.

Batteries must be installed in the transmitter for DSC operation.

Batteries must be installed in the battery powered model for DSC operation.

Be sure to disconnect the DSC cord after using the DSC.

POSITION OF RECEIVER CONNECTORS

Receiver	Position
1.	Steering
2.	Throttle
3.	Auxiliary
4.	Battery or DSC Harness

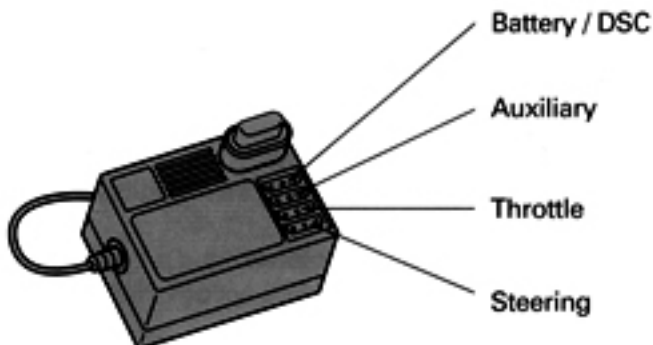

GET THE ADVANTAGE

M8 ALB (anti-lock brake) SUPPLEMENTAL INSTRUCTIONS

WHEN YOU CONTROL BRAKING BY USE OF THE "ALB" FEATURE, VEHICLE BRAKING TIME WILL BECOME SHORTER AND SMOOTHER. THIS CAN RESULT IN BEING ON A BETTER LINE TO ACCELERATE OUT OF CORNERS.

1. Move the cursor to the upper right corner past the **ST SPEED TH** on the screen. You can either select ALB 'ON' or 'OFF' by depressing inc/+ or dec/- key as LCD indicates it is 'ON' or 'OFF'.
2. Depress ★ key, LCD will indicate: ALB-POS 0-100% (initial setting is 90%). This sets the trigger at what point the ALB starts. You can increase or decrease this percentage by depressing inc/+ or dec/- (0-100%).
3. Depress ★ key, LCD will indicate: ALB-STK 50% (stroke). You can increase or decrease the percentage of how hard or soft the ALB activates by pressing the inc/+ or dec/- key.
4. Depress ★ key, LCD will indicate: ALB-LAG 0.5 sec initial setting (anti-lock time delay). This indicates how fast the ALB will activate after the trigger comes into the preset ALB position as programmed above, You can increase or decrease this time delay by depressing inc/+ or dec/- key (0.0-2.0 sec range).
5. Depress ★ key, LCD will indicate: ALB-SPD -2 is initial setting (speed). You can increase or decrease the number or brake applications in a given time frame by depressing the inc/+ or dec/- key (0 is fastest, -10 is slowest rate).
6. It is NOT necessary to use Airtronics part #96900 Anti-Lock Brake Booster with M8 system.